

ICOM

INSTRUCTION MANUAL

UHF SRBR

IC-F4SR

Icom Inc.

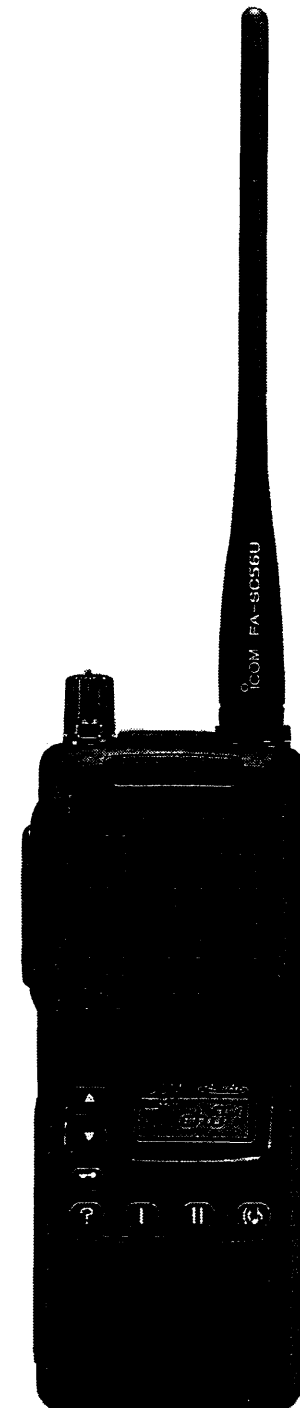

FOREWORD

READ ALL INSTRUCTIONS carefully and completely before using the transceiver.

SAVE THIS INSTRUCTION MANUAL — This instruction manual contains important operating instructions for the IC-F4SR.

EXPLICIT DEFINITIONS

The explicit definitions below apply to this instruction manual.

WORD	DEFINITION
⚠ WARNING	Personal injury, fire hazard or electric shock may occur.
CAUTION	Equipment damage may occur.
NOTE	If disregarded, inconvenience only. No risk of personal injury, fire or electric shock.

CE Versions of the IC-F4SR which display "CE" on the serial number seal, comply with the essential requirements of the 89/336/EEC directive for Electromagnetic Compatibility.

CAUTIONS

⚠ WARNING! NEVER hold the transceiver so that the antenna is very close to, or touching exposed parts of the body, especially the face or eyes, while transmitting. The transceiver will perform best if the microphone is 5 to 10 cm away from the lips and the transceiver is vertical.

⚠ WARNING! NEVER operate the transceiver with a headset or other audio accessories at high volume levels. Hearing experts advise against continuous high volume operation. If you experience a ringing in your ears, reduce the volume level or discontinue use.

NEVER connect the transceiver to an AC outlet or to a power source of more than 16 V DC. Such a connection will damage the transceiver.

NEVER connect the transceiver to a power source that is DC fused at more than 5 A. Accidental reverse connection will be protected by this fuse, higher fuse values will not give any protection against such accidents and the transceiver will be ruined.

NEVER attempt to charge alkaline or dry cell batteries. Beware that external DC power connections will charge batteries inside the battery case. This will damage not only the battery case but also the transceiver.

SUPPLIED ACCESSORIES

DO NOT push the PTT when not actually desiring to transmit.

DO NOT allow children to play with any radio equipment containing a transmitter.

DO NOT operate the transceiver near unshielded electrical blasting caps or in an explosive atmosphere.

AVOID using or placing the transceiver in direct sunlight or in areas with temperatures below -20°C or above $+55^{\circ}\text{C}$.

The use of non-Icom battery packs/chargers may impair transceiver performance and invalidate the warranty.

Even when the transceiver power is OFF, a slight current still flows in the circuits. Remove the battery pack or case from the transceiver when not using it for a long time. Otherwise, the battery pack or installed dry cell batteries will become exhausted.

Accessories included with the transceiver:	Qty.
① Antenna* ¹	1
② Belt clip	1
③ Battery pack or case attached to the transceiver* ²	1
④ Wall charger* ³	1
⑤ 1922A REAR-SHEET (for dealer use)	1

*¹U.K. version do not include an antenna.

*²The battery pack (BP-195) or case (BP-194) may differ depending on version.

*³U.K. version with battery pack and all versions with battery case do not include a wall charger.

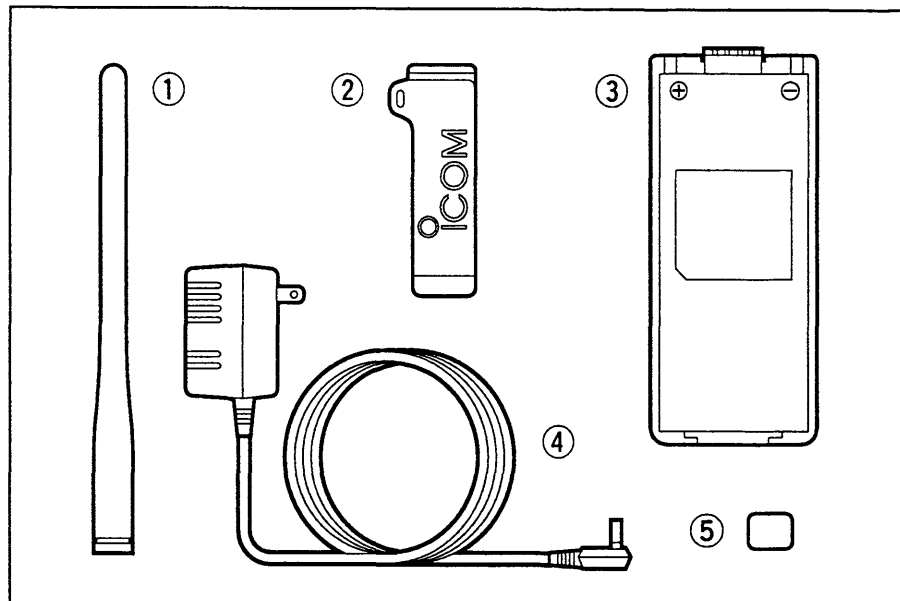

TABLE OF CONTENTS

FOREWORD	i	5 RINGER FUNCTION	10–11	8 BATTERY PACKS	18–20
EXPLICIT DEFINITIONS	i	■ Ringer operation	10	■ Charging precautions	18
CAUTIONS	i	■ Ringer pattern	10	■ Battery pack charging	18
SUPPLIED ACCESSORIES.....	ii	■ Ringer timer	10	■ About the battery pack	20
TABLE OF CONTENTS	iii	■ Auto channel function	11	■ Installing batteries in the	
1 ACCESSORY ATTACHMENT	1	■ Auto reset timer	11	battery case	20
2 PANEL DESCRIPTION	2–4	6 TONE SQUELCH/DTCS	12–15	9 TROUBLESHOOTING	21
■ Panel description	2	■ Operation	12	10 SPECIFICATIONS	22
■ Function display	4	■ Setting a tone or code	12	11 OPTIONS	23
3 BASIC OPERATION	5–8	■ Tone number indication	13		
■ Receiving and transmitting	5	■ Pocket beep operation	14		
■ Customizable keys	6	■ Pocket beep pattern	14		
■ Lock function	6	■ Tone scan	15		
■ Monitor function	6	7 OTHER FUNCTIONS	16–17		
■ All channel mode and select		■ Power saver	16		
channel mode	7	■ Confirmation beeps	16		
■ Select channel setting	7	■ Transmit lockout	16		
■ Display backlighting	8	■ All reset	16		
4 SCAN OPERATION	9	■ “My name” function	17		
■ Scan types	9	■ Optional HM-75A functions	17		
■ Starting a scan	9				

◇ Antenna

CAUTION: Transmitting without an antenna may damage the transceiver.

Insert the supplied antenna into the antenna connector and screw down the antenna as shown at right.

Keep the jack cover attached when jacks are not in use to avoid bad contacts from dust and moisture.

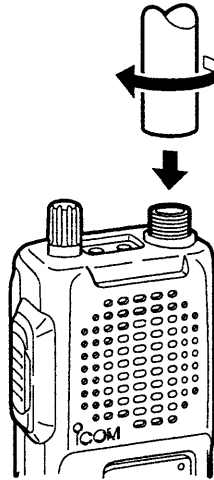

◇ Belt clip

Conveniently attaches to your belt.

To attach:

Slide the belt clip into the plastic loop on the back of the battery case/pack.

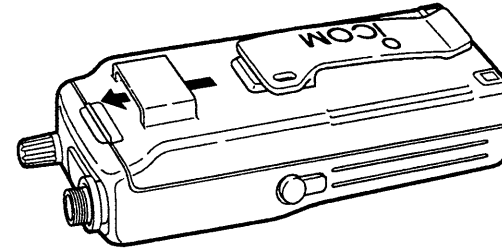

To remove:

Push the top of the belt clip towards the transceiver and at the same time, push it downward and free of the plastic loop.

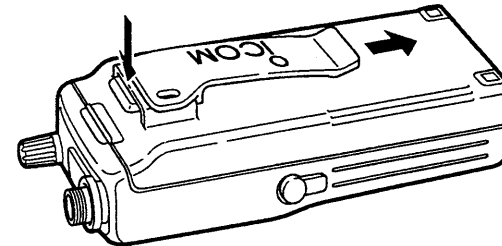

◇ Battery pack replacement

To remove:

Push and hold the battery release downwards, then pull the battery pack upwards as shown at right.

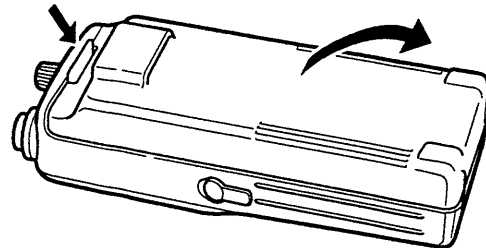

To attach:

Mate the notched ends of the battery pack and the transceiver, and push the battery pack until it clicks into place.

■ Panel description

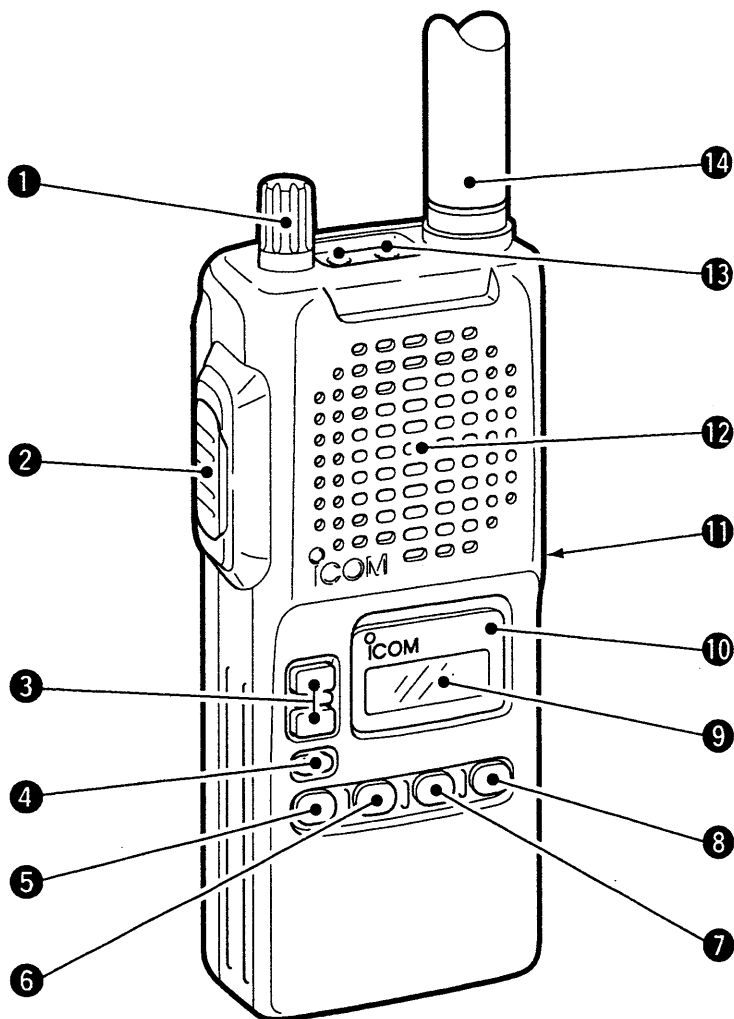

① VOLUME CONTROLS [VOL] (p. 5)

Turns power ON and adjusts the audio level.

② PTT SWITCH [PTT] (p. 5)

Push and hold to transmit; release to receive.

③ CHANNEL UP/DOWN KEYS [▲]/[▼]

➔ Push to select the operating channel. (p. 5)

➔ Push and hold to select the operating channel continuously. (p. 5)

- The selection stops on channel 1 with a beep.

④ KEY LOCK SWITCH []

Toggles the lock function ON and OFF when pushed for 2 sec. (p. 6)

- " " appears when the lock function is activated.

⑤ MONITOR KEY [?]

➔ Push to toggle the receive tone/DTCS squelch ON or OFF. (p. 12)

- " " appears when the receive tone/DTCS squelch is turned OFF.

- This function is not available for some versions.

➔ Monitors the selected channel when pushed and held. (p. 6)

6 CUSTOMIZABLE KEY 1 [I] (p. 6)

7 CUSTOMIZABLE KEY 2 [II]

Activate the following customizable functions. 2 functions can be programmed into the [I]/[II] key at power ON.

- These function cannot be changed depending on dealer setting.

[NULL]	Null switch (backlight when used)
[CODE]	CTCSS tone/DTCS code switch
[A/S]	All/select channel switch (default of [I])
[SCAN]	Scan switch
[PO BEEP]	Pocket beep switch
[MY NAME]	“My name” switch (default of [II])
[AUTO CH]	Auto channel switch

NOTE: In this manual, the customizable keys are represented by the [★] icon. Operations which require a customizable key observe the following style—

Push [★(FUNCTION)]

where “★” indicates the key is customizable and “FUNCTION” indicates the assigned function e.g. CODE, etc.

8 RINGER KEY [(r)]

Transmits a ringer tone.

- 1 of 10 ringer types can be selected at power ON. (p. 10)
- When the auto channel function is activated, pushing this key repeatedly transmits the ringer tone for the ringer time.

9 FUNCTION DISPLAY (p. 4)

10 TRANSMIT INDICATOR (p. 5)

Lights red while transmitting.

11 EXTERNAL DC POWER JACK [CHARGE]

Connect a 12 to 16 V DC power source using the optional cables, CP-12L or OPC-254L, to charge the attached battery pack; or connect the BC-110D (non-U.K. versions) wall charger for charging.

CAUTION: This connection is for charging ONLY. Power to the transceiver must be turned OFF during charging.

12 SPEAKER/MICROPHONE

13 EXTERNAL SPEAKER AND MICROPHONE JACKS [SP/MIC]

Connect an optional speaker-microphone or headset, if desired. The internal microphone and speaker will not function when either is connected. (See p. 23 for a list of available options.)

14 ANTENNA CONNECTOR (p. 1)

Connects the supplied antenna.

2 PANEL DESCRIPTION

■ Function display

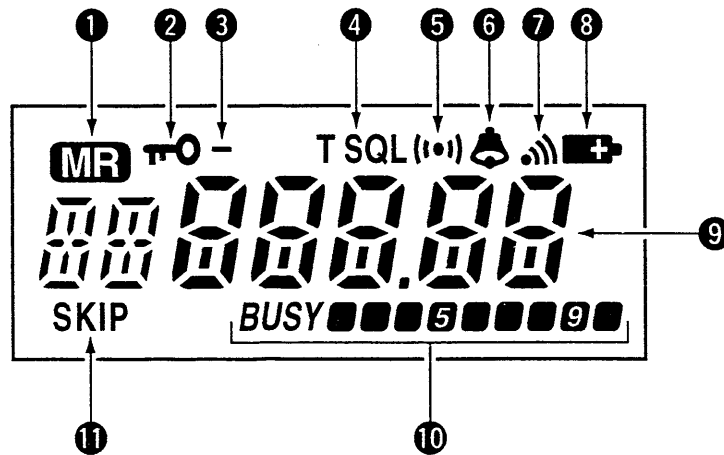

❶ SELECT CHANNEL MODE INDICATOR (p. 7)

Appears when select channel mode is selected. Disappears when all channel mode is selected.

❷ LOCK INDICATOR (p. 6)

Indicates that the lock function is in use.

❸ INVERSE DTCS CODE INDICATOR (p. 12)

Appears when setting an inverse DTCS code.

❹ TONE SQUELCH/DTCS INDICATOR (p. 12)

Appears when setting a tone squelch frequency or DTCS code, etc.

❺ RINGER INDICATOR (p. 10)

“(•)” appears while transmitting a ringer signal.

❻ POCKET BEEP INDICATOR (p. 14)

“🔔” appears during pocket beep operation.

❼ RECEIVE TONE/DTCS SQUELCH OFF INDICATOR

➔ Appears when the receive tone/DTCS squelch is turned OFF. (p. 12)

• This function is not available for some versions.

➔ Appears when the monitor function is in use. (p. 6)

❽ LOW BATTERY INDICATOR

➔ Appears when the battery is nearing exhaustion.

➔ Appears and flashes when battery replacement is necessary.

❾ CHANNEL READOUT

Shows the operating channel, tone frequency, DTCS code, set mode contents, etc.

❿ BUSY AND SIGNAL INDICATORS

➔ “BUSY” appears when receiving a signal or when the squelch is open.



➔ The signal indicators show the relative signal strength while receiving.

⓫ NON-SELECT CHANNEL INDICATOR (p. 7)

Appears when a non-select channel is selected.

■ Receiving and transmitting

CAUTION: Transmitting without an antenna may damage the transceiver.

- ① Rotate [VOL] clockwise to turn power ON, then set to the 10 o'clock position.
 - If “]/[] switches.
 - When receiving a signal, “BUSY” appears and audio is emitted from the speaker.
 - Further adjustment of [VOL] may be necessary at this point.
 - Push [?] to toggle the tone squelch ON and OFF. (p. 12, This function is not available for some versions.)
 - Push and hold [?] to monitor the operating channel. (p. 6)
 - ③ Push and hold [PTT] to transmit, then speak into the microphone.
 - Transmit indicator lights.
 - ④ Release [PTT] to receive.

IMPORTANT: To maximize the readability of your transmitted signal, pause a few sec. after pushing [PTT], hold the microphone 10 to 15 cm from your mouth and speak at a normal voice level.

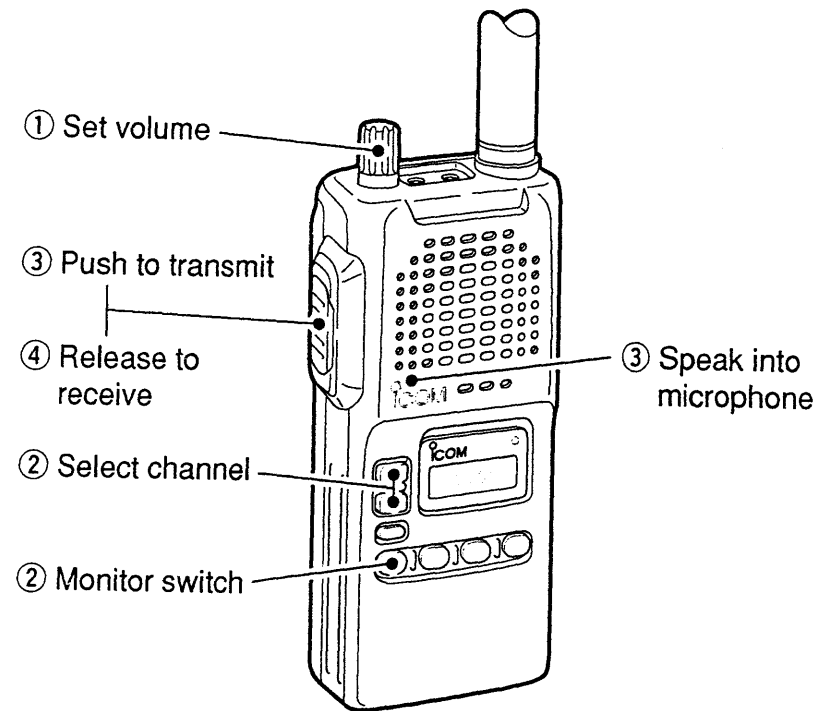

NOTE: The transceiver has a power save function to conserve battery power. The power save function activates automatically when no signal is received for 5 sec.

3 BASIC OPERATION

■ Customizable keys

The customizable keys activate the following functions. 2 functions can be programmed into the [I]/[II] key at power ON. Assign the desired function as follows:

- This function is not available depending on dealer setting.

Usable functions:

[NULL]	Null switch (backlight when used)
[CODE]	CTCSS tone/DTCS code switch
[A/S]	All/select channel switch (default of [I])
[SCAN]	Scan switch
[PO BEEP]	Pocket beep switch
[MY NAME]	“My name” switch (default of [II])
[AUTO CH]	Auto channel switch

- ① While pushing [▲] + [I] or [▲] + [II], turn power ON to change the function of the customizable key.
 - The selected function name is displayed for a moment.
 - Functions can be selected in the above order.
- ② Turn power OFF.
- ③ Repeat steps ① and ② until the desired function is selected.

■ Lock function

The lock function prevents accidental channel changes and accidental function access. [PTT], [?] and the backlight function can be used while the lock function is in use.

- ➔ Push [] for 2 sec. to toggle the lock function ON and OFF.

“” appears when the lock function is in use.

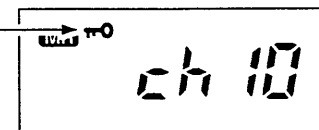

■ Monitor function

This function is used to listen to weak signals or to open the tone squelch manually.

- ➔ Push and hold [?] to monitor the operating channel.



“” and “BUSY” appear when the monitor function is in use.

■ All channel mode and select channel mode

The transceiver has 2 indication modes—all channel mode and select channel mode.

Select channel mode provides easy, fast channel selection and speeds up the scan interval. Non select channels are not displayed while in select channel mode.

➔ Push [A/S] to toggle all channel mode or select channel mode.

- “MR” appears when the select channel mode is selected.

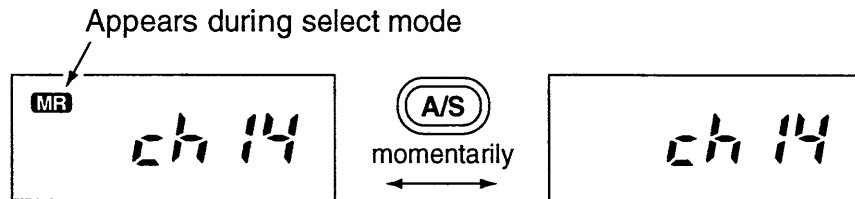

■ Select channel setting

Setting a channel as the select channel provides easy, fast channel selection and speeds up the scan interval.

- ① Push [A/S] to select all channel mode.
 - “MR” disappears.
- ② Select the desired channel with the [▲]/[▼] switches.
- ③ Push [A/S] for 2 sec. to toggle the channel between select channel and non-select channel.
 - “SKIP” disappears for a select channel.

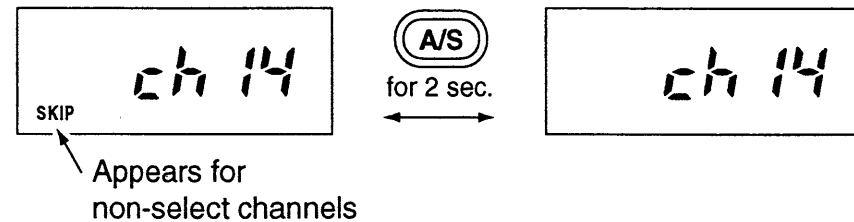

3 BASIC OPERATION

■ Display backlighting

The transceiver has display backlighting with a 5 or 10 sec. timer for nighttime operation. The display backlighting can be turned ON continuously or turned OFF, if desired.

- ➔ Push any switch except [PTT] to turn the backlighting ON.
 - When the 5 or 10 sec. timer is set, the backlighting will automatically turn OFF when switches have not been operated for 5 or 10 sec., respectively.

◇ Setting the backlighting timer USING SET MODE

- ① While pushing [▲] + [?], turn power ON to enter set mode.
 - Set mode is not available depending on dealer setting.
- ② Push [?] several times until "LI" appears.
- ③ Push [▲] or [▼] to select the backlighting timer.
- ④ Turn power OFF to exit set mode.

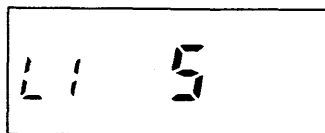

5 sec. timer

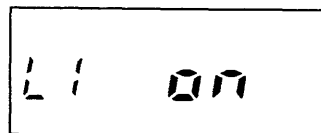

Continuously ON

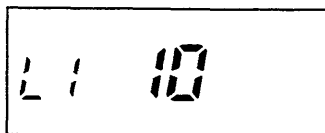

10 sec. timer

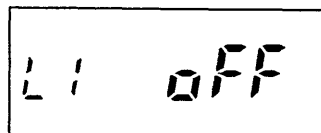

Continuously OFF

■ Scan types

Scanning is an efficient way to locate signals quickly over all channels.

Setting select channels and using select channel mode (p. 7) speed up the scanning interval.

In addition, the auto channel function is available for standby convenience. (p. 11)

SCAN in all channel mode

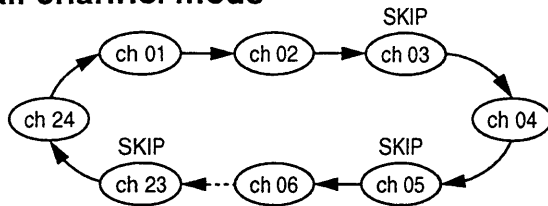

Repeatedly scans all channels including non-select channels in sequence.

SCAN in select channel mode

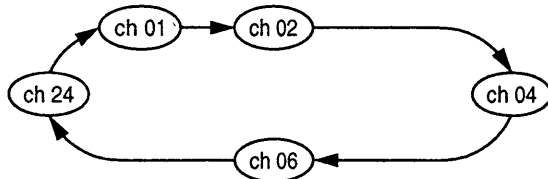

Repeatedly scans select channels only, in sequence.

■ Starting a scan

To speed up the scanning interval, set desired channels as select channels and set select channel mode in advance. (p. 7)

- ① Push [**▲**(SCAN)] to start the scan.
 - Decimal point flashes while scanning.

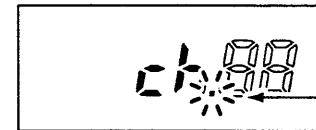

Flashes while scanning.

- ② When receiving a signal, scan pauses and resumes according to the included CTCSS frequency or DTCS tone. (p. 12)
 - When the code is matched, scan resumes 5 sec. after the signal disappears.
 - When the code is not matched, scan resumes immediately.
- ③ Push [**▲**(SCAN)] to stop the scan.

■ Ringer operation

The ringer function is used to call a waiting station with a ring or similar tones. 10 kinds of ring tones are available.

- ① Select the desired channel with the [▲]/[▼] switches.
- ② Push [(P)] for a desired time to call the waiting station.
 - “(·)” appears while transmitting a ring tone.
 - The ringer tones are repeatedly transmitted when this key is pushed and held.
- ③ Waiting station receives the ringer tones.
- ④ Operate the transceiver in the normal way.

■ Ringer pattern

USING SET MODE

10 ringer patterns are available. Select the desired ringer pattern as follows:

- ① While pushing [▼] + [(P)], turn power ON to enter ringer pattern set mode.
 - “RG” and the selected ringer pattern number appear.
- ② Push [▲] or [▼] to select the ringer pattern.
 - The selected pattern is played once.
- ③ Turn power OFF to exit set mode.

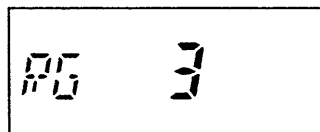

Ringer pattern 3

■ Ringer timer

USING SET MODE

Ringer time is the minimum transmission time of the ringer tones when the auto channel function is in use. 0 to 16 sec. in 1 sec. steps can be programmed.

- ① While pushing [▲] + [?], turn power ON to enter set mode.
 - Set mode is not available depending on dealer setting.
- ② Push [?] several times until “Rt” appears.
- ③ Push [▲] or [▼] to select the ringer timer.
- ④ Turn power OFF to exit set mode.

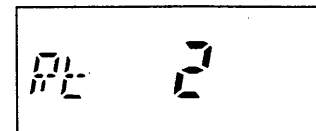

2 sec. ringer time

The minimum transmit time can be set greater than the waiting period of the auto channel function. (p. 11) The recommended ringer time depends on the number of receive stations:

2 or 3 channels	2 sec.
4 or 5 channels	3 sec.
6 or 7 channels	4 sec.

■ Auto channel function

The auto channel function automatically checks for calling signals or ringer signals on all or select channels.

If you hear ringer tone, specified in set mode, you can answer the call by simply pushing the [PTT] switch. It is not necessary to select a channel first.

- ① Push [**A**] (AUTO CH) to turn the auto channel function ON.
 - "A" appears and scan starts.

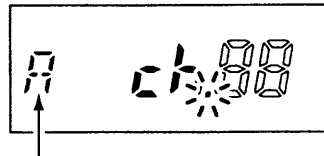

"A" appears while the auto channel function is in use.

- ② When receiving a ringer tone, push [PTT] to answer.
- ③ To call a waiting station, push [**Ⓟ**] to transmit a ringer tone.
 - To call a waiting station by voice, push [PTT] until beep tones sound (for longer than the ringer time), then speak into the microphone.
- ④ When the auto reset timer is turned OFF, push [**A**] (AUTO CH) to restart the auto channel function.
- ⑤ Push [**A**] (AUTO CH) to cancel the function.

■ Auto reset timer

USING SET MODE

Auto reset time is the period before the auto channel function restarts after a busy signal disappears and in which no operation is performed while the auto channel function is in use.

5 to 60 sec. in 5 sec. steps or OFF can be programmed.

- ① While pushing [**▲**] + [**?**], turn power ON to enter set mode.
 - Set mode is not available depending on dealer setting.
- ② Push [**?**] several times until "AR" appears.
- ③ Push [**▲**] or [**▼**] to select the auto reset time or to turn the function OFF.
- ④ Turn power OFF to exit set mode.

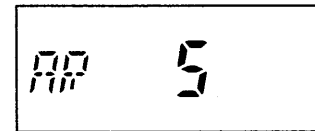

5 sec. auto reset time

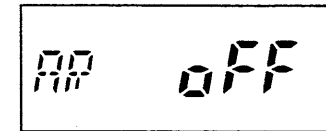

Auto reset timer is cancelled.

■ Operation

By default, the transceiver uses a CTCSS/DTCS squelch system. The CTCSS tone squelch/DTCS opens only when receiving a signal containing a matching tone. You can silently wait for calls from group members using the same tone.

- ① Push [▲] or [▼] to select the desired channel.
- ② Set the desired tone or code as described at right.
- ③ Push [?] to turn the receive tone squelch ON.
 - “ - When the received signal's tone does not match, tone squelch does not open, however, the S-indicator shows signal strength.
 - To open the squelch temporarily, push and hold [?].

NOTE: The transceiver has 50 CTCSS tone frequencies and consequently their spacing is narrow compared with units having 38 tones. Therefore, some tone frequencies may receive interference from adjacent tone frequencies.

Tone frequencies or DTCS code settings are automatically stored in memory channels for easy recall.

■ Setting a tone or code

50 CTCSS tones and 84 DTCS codes are available.

- ① Push [▲] or [▼] to select a channel.
- ② Push [↵ (CODE)].
 - Current tone or code appears.
- ③ Push [▲] or [▼] to select the CTCSS tone frequency or DTCS code.
 - “-” appears when an inverse DTCS code is selected.
- ④ Push [↵ (CODE)] to exit.

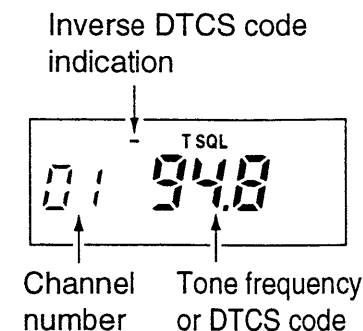

CTCSS TONE FREQUENCY

(Unit: Hz)

No.	Freq.	No.	Freq.	No.	Freq.	No.	Freq.	No.	Freq.
01	67.0	11	94.8	21	131.8	31	171.3	41	203.5
02	69.3	12	97.4	22	136.5	32	173.8	42	206.5
03	71.9	13	100.0	23	141.3	33	177.3	43	210.7
04	74.4	14	103.5	24	146.2	34	179.9	44	218.1
05	77.0	15	107.2	25	151.4	35	183.5	45	225.7
06	79.7	16	110.9	26	156.7	36	186.2	46	229.1
07	82.5	17	114.8	27	159.8	37	189.9	47	233.6
08	85.4	18	118.8	28	162.2	38	192.8	48	241.8
09	88.5	19	123.0	29	165.5	39	196.6	49	250.3
10	91.5	20	127.3	30	167.9	40	199.5	50	254.1

■ Tone number indication

The transceiver can display CTCSS tones and DTCS codes using 2-digit numbers.

CTCSS tones are indicated as 01 to 50. DTCS codes are indicated as A0 to A9, B0 to B9, etc. as shown at left.

DTCS CODE

No.	Code	No.	Code	No.	Code	No.	Code	No.	Code
A0	023	B0	065	C0	132	D0	205	E0	271
A1	025	B1	071	C1	134	D1	223	E1	306
A2	026	B2	072	C2	143	D2	226	E2	311
A3	031	B3	073	C3	152	D3	243	E3	315
A4	032	B4	074	C4	155	D4	244	E4	331
A5	036	B5	114	C5	156	D5	245	E5	343
A6	043	B6	115	C6	162	D6	251	E6	346
A7	047	B7	116	C7	165	D7	261	E7	351
A8	051	B8	125	C8	172	D8	263	E8	364
A9	054	B9	131	C9	174	D9	265	E9	365
F0	371	G0	466	H0	627	I0	732		
F1	411	G1	503	H1	631	I1	734		
F2	412	G2	506	H2	632	I2	743		
F3	413	G3	516	H3	654	I3	754		
F4	423	G4	532	H4	662				
F5	431	G5	546	H5	664				
F6	432	G6	565	H6	703				
F7	445	G7	606	H7	712				
F8	464	G8	612	H8	723				
F9	465	G9	624	H9	731				

◇ Setting tone number indication USING SET MODE ON/OFF

- ① While pushing [▲] + [?], turn power ON to enter set mode.
 - Set mode is not available depending on dealer setting.
- ② Push [?] several times until "to" appears.
- ③ Push [▲] or [▼] to turn the tone number indication ON or OFF, respectively.
 - "nUm" :
Tone frequency and DTCS code are displayed by number.
 - "CodE" :
Tone frequency and DTCS code are displayed by code.
- ④ Turn power OFF to exit set mode.

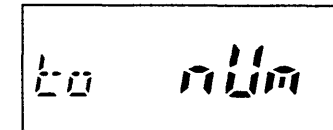

Tone number indication ON

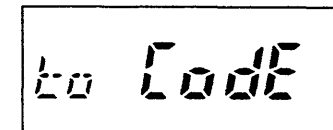



Tone number indication OFF

■ Pocket beep operation

By default, the transceiver uses a CTCSS/DTCS squelch system. Using this system, you can determine that someone has called while you were away from the transceiver—much like a “common pager.”

◇ Waiting for a call from a specific station

- ① Select the desired channel with the [▲]/[▼] switches.
 - If “ - See p. 12 for programming information.
- ③ Push [▼] (PO BEEP) to activate the pocket beep. (p. 14)
 - “

◇ Calling a waiting station using pocket beep

A tone or code matched with the station’s tone frequency is necessary.

- ① Select the desired channel with the [▲]/[▼] switches.
- ② Set the desired tone or code.
- ③ Push [PTT] to call the waiting station.
- ④ Wait for the answer back call.

■ Pocket beep pattern

The pocket beep pattern, when receiving a matched CTCSS tone/DTCS code, can be selected from 6 patterns.

◇ Setting the pocket beep pattern

- ① While pushing [▼] + [II], turn power ON to enter the pocket beep pattern setting condition.
- ② Push [▲] or [▼] to select the desired pocket beep pattern.
 - 1 1 high beep once.
 - 2 2 high beeps once.
 - 3 1 high and 1 low beep 3 times.
 - 4 1 high beep repeated at fixed intervals.
 - 5 2 high beeps repeated at fixed intervals.
 - 6 1 high, 1 low beep 3 times, repeated at fixed intervals.

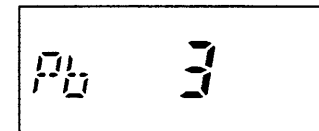

Pocket beep pattern 3

- ③ Turn power OFF to exit set mode.

■ Tone scan

The transceiver can detect the tone frequency or DTCS code in a received signal. By monitoring a signal that is being transmitted on the channel, you can determine the tone or code required to open the receiving station's squelch.

- ① Push [▲] or [▼] to select the desired channel.
- ② Push [★(CODE)] for 2 sec. to start tone scan.

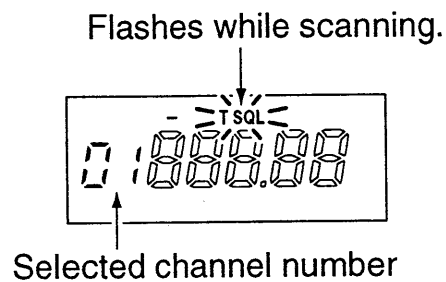

- ③ When a matched tone or code is detected, the tone scan stops automatically.
 - The detected tone or code is automatically memorised into the channel.
- ④ Push [★(CODE)] to cancel the tone scan, if necessary.

Power saver

USING SET MODE

The power saver function reduces the current drain to conserve battery power.

- ① While pushing [▲] + [?], turn power ON to enter set mode.
 - Set mode is not available depending on dealer setting.
- ② Push [?] several times until “PS” appears.
- ③ Push [▲] or [▼] to turn the power saver ON or OFF, respectively.
- ④ Turn power OFF to exit set mode.

Confirmation beeps

USING SET MODE

You can select silent operation by turning beep tones OFF or you can have confirmation beeps sound at the push of a switch by turning beep tones ON. The beep tone volume is linked with [VOL].

- ① While pushing [▲] + [?], turn power ON to enter set mode.
 - Set mode is not available depending on dealer setting.
- ② Push [?] several times until “bE” appears.
- ③ Push [▲] or [▼] to turn the confirmation beeps ON or OFF, respectively.
- ④ Turn power OFF to exit set mode.

Transmit lockout

USING SET MODE

The transmit lockout function inhibits transmission while receiving a signal.

- ① While pushing [▲] + [?], turn power ON to enter set mode.
 - Set mode is not available depending on dealer setting.
- ② Push [?] several times until “Lo” appears.
- ③ Push [▲] or [▼] to turn the transmit lockout function ON or OFF, respectively.
 - “bUSy” :
Transmission is impossible when receiving a signal.
 - “oFF” :
Transmission is always possible.
- ④ Turn power OFF to exit set mode.

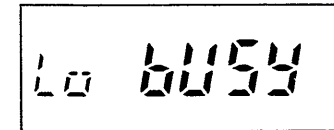

Transmission is impossible when receiving a signal.

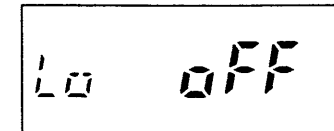

Lockout function is cancelled.

All reset

Reset the CPU when the internal CPU malfunctions.

• All reset may not be available depending on dealer setting.

- ① While pushing [▲], [▼] and [⏏], turn power ON.
- ② Release [▲], [▼] and [⏏] after “CLEAR” disappears.

CAUTION: Resetting the CPU returns all programmed contents to their default settings.

■ “My name” function

The transceiver displays its name (or a comment) within 7 characters when turning power ON and when the [▼(MY NAME)] key is pushed.

➔ Push [▼(MY NAME)] to display the name.

◇ Programming “my name”

- ① While pushing [▲] + [⏏], turn power ON to enter “my name” set mode.
 - Set mode is not available depending on dealer setting.
- ② Push [▲] or [▼] to select a character.
 - Usable characters: A to Z, 0 to 9, [,], -, / and Space
- ③ Push [⏏] to advance the cursor.
- ④ Repeat steps ② and ③ until the desired name or comment appears.
- ⑤ Push [⏏] for 2 sec. to exit set mode.



■ Optional HM-75A functions

CAUTION: When connecting the HM-75A to the transceiver, make sure that power to the transceiver is turned OFF, otherwise the CPU may malfunction.

◇ Turning the microphone remote control function ON/OFF

- ① While pushing [▲] + [?], turn power ON to enter set mode.
 - Set mode is not available depending on dealer setting.
- ② Push [?] several times until “mC” appears.
- ③ Push [▲] or [▼] to turn the microphone remote control function ON or OFF, respectively.
- ④ Turn power OFF to exit set mode.

◇ HM-75A functions

The optional HM-75A allows you to remotely select operating channels, output power, etc.

A SWITCH

- Toggles tone/DTCS squelch function ON and OFF when pushed.
- Monitors the selected channel when pushed and held.

B SWITCH

Transmits a ringer tone.

▲/▼ SWITCHES

Selects the operating channels.

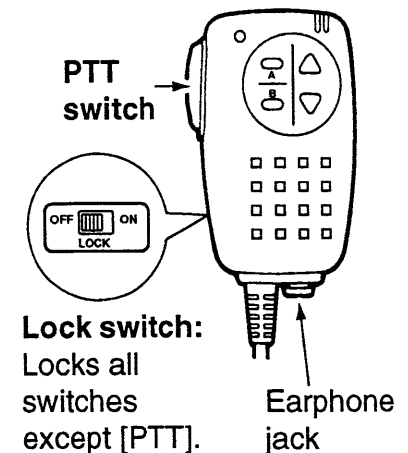

■ Charging precautions

NEVER attempt to charge dry cell batteries. This will cause internal liquid leakage and damage the battery case and transceiver.

NEVER connect two or more chargers at the same time.

Charging may not occur under temperatures of 10°C (50°F) or over temperatures of 40°C (104°F).

When using BC-119: If the charge indicator flashes orange, vehicle battery voltage is low and charging is not possible. Check the vehicle battery voltage in this case. If the charge indicator flashes red, there may be a problem with the battery pack (or charger). Re-insert the battery pack or contact your dealer.

■ Battery pack charging

The BP-195 or BP-196 BATTERY PACK includes rechargeable Ni-Cd batteries and can be charged approx. 300 times. Charge the battery pack before first operating the transceiver or when the battery pack becomes exhausted.

If you want to be able to charge the battery pack more than 300 times, the following points should be observed:

1. Avoid overcharging. The charging period should be less than 48 hours.
2. Use the battery until it becomes almost completely exhausted under normal conditions. We recommend battery charging just after transmitting becomes impossible.

◇ Rapid charging with the BC-119

The optional BC-119 provides rapid charging of battery packs.

One AD-81 and an AC adapter (may be supplied with the BC-119 depending on version) are additionally required.

- **Charging periods:** 1.5 hours (w/BP-195)
2 hours (w/BP-196)

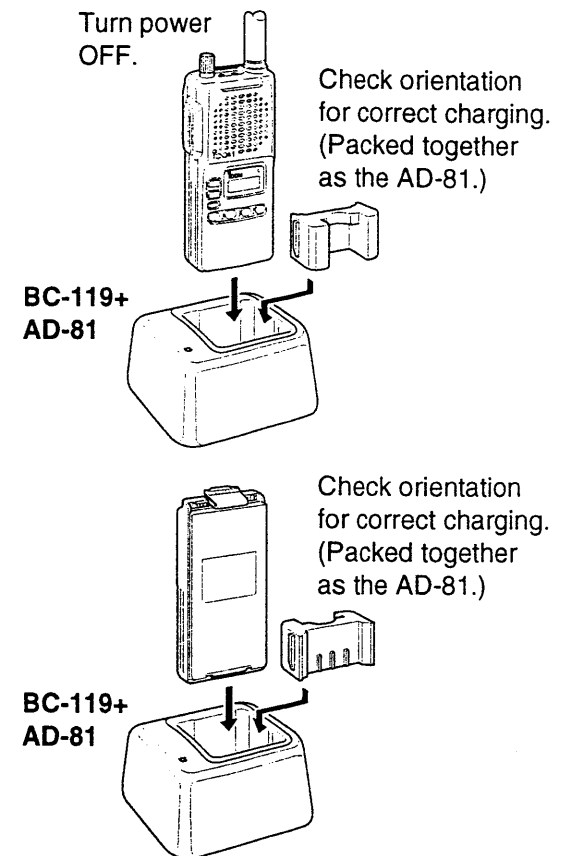

◇ Multiple charging with the BC-121

The optional BC-121 allows up to 6 battery packs to be charged simultaneously.

Six AD-81's and an AC adapter (may be supplied with the BC-121 depending on version) are additionally required.

- **Charging periods:** 1.5 hours (w/BP-195)
2 hours (w/BP-196)

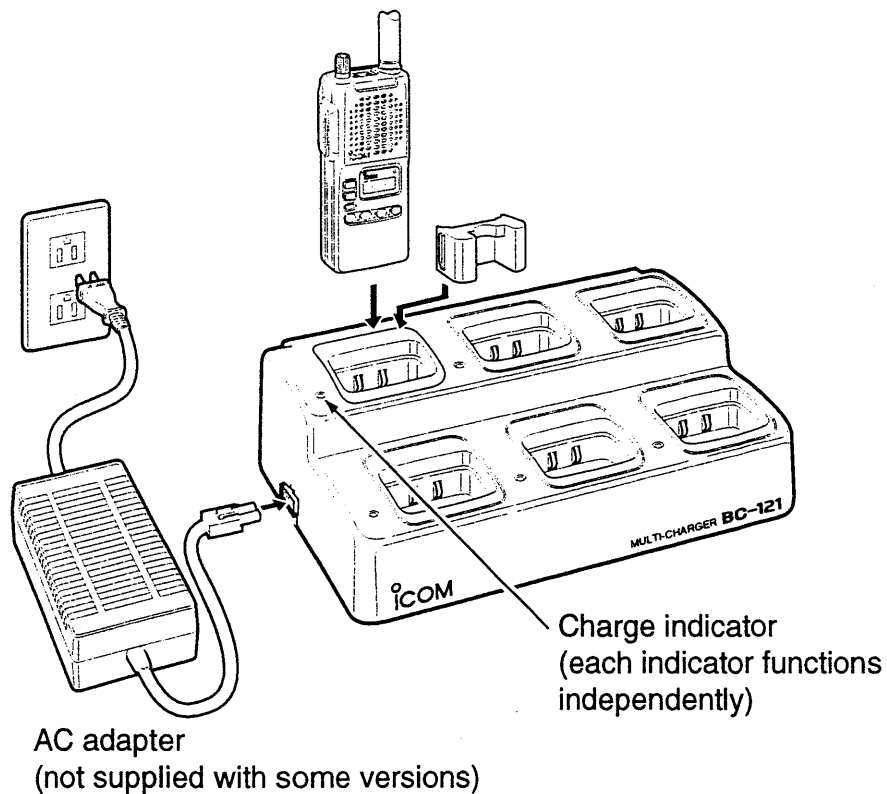

◇ Regular charging

- ① Attach the battery pack to the transceiver.
- ② Be sure to turn the transceiver power OFF.
- ③ Connect the AC adapter (BC-110D) or optional cable (CP-12L or OPC-254L) as shown below.

- **Charging periods:** 10 hours (w/BP-195)
15 hours (w/BP-196)

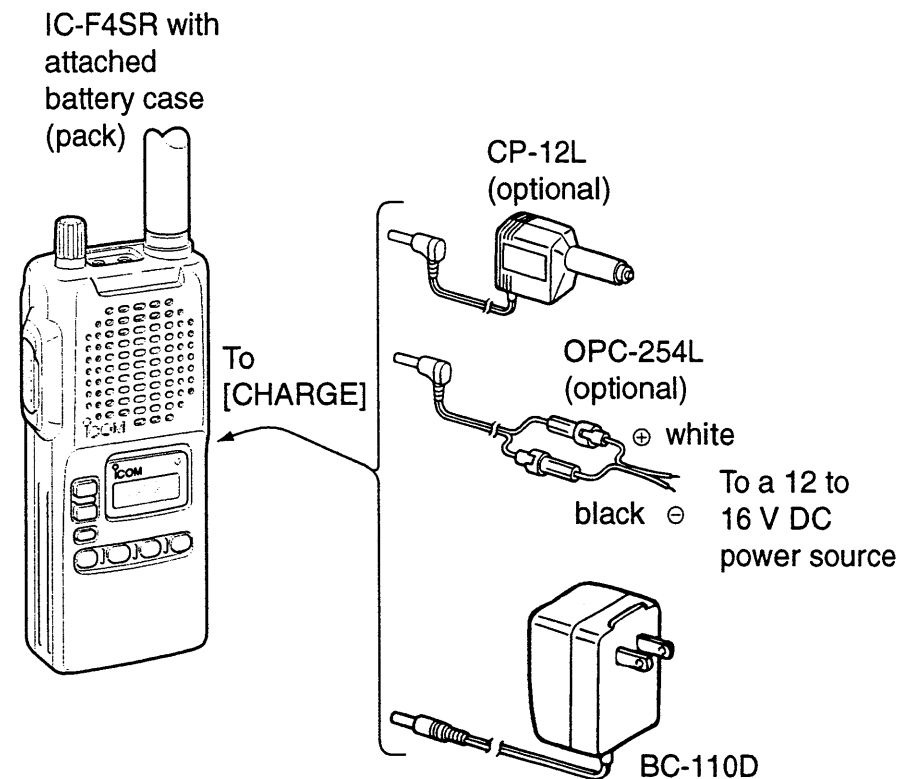

■ About the battery pack

◇ Operating period

Depending on the attached battery pack, the operating period of the transceiver varies. Refer to the last page for battery pack specifications.

◇ Battery pack life

If your battery pack seems to have no capacity even after being fully charged, completely discharge it by leaving the power ON overnight. Then, fully charge the battery pack again.

If the battery pack still does not retain a charge (or very little), a new battery pack must be purchased.

■ Installing batteries in the battery case

When using a battery case, install 8 AA (R6) size Ni-Cd or alkaline batteries as illustrated below.

- ① Remove the battery case from the transceiver.

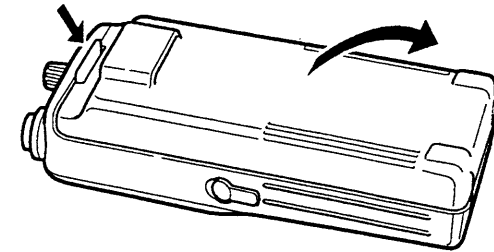

- ② Install 8 AA (R6) size Ni-Cd or alkaline batteries.
 - Be sure to observe the correct polarity.

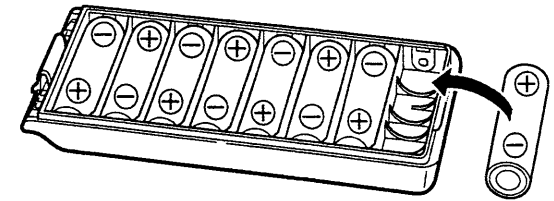

- **NEVER** connect DC power to the transceiver when installing dry cell or alkaline batteries. Such a connection will damage the transceiver.
- Be careful of battery overcharging. When operating via external DC power, installed batteries are simultaneously charged.
- Keep battery contacts clean. It's a good idea to clean battery terminals once a week.

If your transceiver seems to be malfunctioning, please check the following points before sending it to a service center.

PROBLEM	POSSIBLE CAUSE	SOLUTION	REF.
No power comes ON.	<ul style="list-style-type: none"> •The battery is exhausted. •Bad connection to the battery pack. 	<ul style="list-style-type: none"> •Recharge the battery pack. •Check the connection to the transceiver. 	p. 18 —
No sound comes from the speaker.	<ul style="list-style-type: none"> •Volume level is too low. •Different tone or code is selected. 	<ul style="list-style-type: none"> •Set [VOL] to a suitable level. •Check the tone using tone scan. 	p. 5 p. 15
Transmitting is impossible.	<ul style="list-style-type: none"> •The battery is exhausted. 	<ul style="list-style-type: none"> •Recharge the battery pack. 	p. 18
No contact possible with another station.	<ul style="list-style-type: none"> •Different channel is selected. •Different tone or code is selected. 	<ul style="list-style-type: none"> •Use scan in all channel mode. •Check the tone using tone scan. 	p. 9 p. 15
The displayed channel cannot be changed.	<ul style="list-style-type: none"> •Lock function is activated. 	<ul style="list-style-type: none"> •Push [] for 2 sec. to cancel the function. 	p. 6
Scan starts automatically.	<ul style="list-style-type: none"> •The auto channel function is activated. 	<ul style="list-style-type: none"> •Turn the auto channel function OFF. 	p. 11
No beeps sound.	<ul style="list-style-type: none"> •Confirmation beeps are turned OFF. 	<ul style="list-style-type: none"> •Turn confirmation beeps ON in set mode. 	p. 16

10 SPECIFICATIONS

◇ General

- Frequency coverage (Incl. all SRBR ch.):
 - U.K. 461.2625–461.4875 MHz
 - France 446.9500–446.9875 MHz
 - Sweden 444.6000–444.9750 MHz
- Mode :
 - U.K., France FM (8K50F3E)
 - Sweden FM (16K0F3E)
- Acceptable power supply : 9.6 V DC nominal
(negative ground) (authorized battery packs)
- Usable temp. range : –20°C to +55°C
- Frequency stability : ±5 ppm
- Current drain (approx.) :
 - Tx at 0.5 W ERP 0.9 A
 - Rx standby 60 mA
 - max. audio 250 mA
 - power saved 20 mA
- Antenna impedance : 50 Ω (nominal)
- Dimensions : 57(W) × 140(H) × 37(D) mm
(projections not incl.)
- Weight (with BP-195) : 370 g

◇ Receiver

- Receive system : Double conversion
superheterodyne
- Intermediate frequencies : 1st 46.35 MHz
2nd 450 kHz

- Sensitivity : 0.3 μV at 12 dB SINAD
- Squelch sensitivity : 0.3 μV typical (at threshold)
- Adjacent ch. selectivity :
 - U.K., France 60 dB
 - Sweden 70 dB
- Spurious response : 70 dB
- Intermodulation rejection : 65 dB
- Audio output power : 500 mW typical at 10%
(at 9.6 V DC) distortion with an 8 Ω load
- External SP connector : 2-conductor 3.5 (d) mm/8 Ω

◇ Transmitter

- Output power : 0.5 W ERP (at 9.6 V DC)
- Modulation : Variable reactance frequency
modulation
- Max. frequency deviation :
 - U.K., France ±2.5 kHz
 - Sweden ±5 kHz
- Spurious emissions :
 - U.K., France 0.25 μW
 - Sweden 0.25 μW
- Adjacent channel selectivity :
 - U.K., France 60 dB
 - Sweden 70 dB
- External mic. connector : 3-conductor 2.5 (d) mm/2 kΩ

All stated specifications are subject to change without notice or obligation.

◇ Battery packs

Battery pack	Voltage	Capacity	Charging period		Operating period* ¹
			Wall charger or BC-133	BC-119 or BC-121 with AD-81	
BP-194	Battery case for AA (R6) × 8 alkaline or Ni-Cd cells		10 hrs* ²	N/A	8 hrs* ²
BP-195	9.6 V	700 mAh	10 hrs	1.5 hrs	8 hrs
BP-196	9.6 V	1050 mAh	15 hrs	2.0 hrs	12 hrs

*¹ Operating periods are estimated for the following conditions:
25°C (77°F), Tx (high power) : Rx : standby = 5 : 5 : 90

*² When 700 mAh Ni-Cd batteries are installed.

◇ Other options

BC-110D WALL CHARGER (non-U.K. versions)

Used for regular charging of the connected battery pack.

BC-119 DESKTOP CHARGER + AD-81 CHARGER ADAPTOR

For rapid charging of battery packs. An AC adapter is supplied with the charger. Some BC-119 versions require the AD-75 additionally. Charging time: 1.5 to 2 hrs.

BC-121 MULTI-CHARGER + AD-81 CHARGER ADAPTOR

For rapid charging up to 6 battery packs simultaneously. An AC adapter may be supplied depending on version. Six AD-81's are necessary. Charging time: 1.5 to 2 hrs.

BC-133 DESKTOP CHARGER + BC-122A/EV AC ADAPTER

For regular charging of battery packs. Up to 6 BC-133's can be connected in parallel when using an optional parallel power cable, OPC-534, and an adequate capacity DC power supply (13.8–16 V DC, 1 A). Charging time: 15 to 20 hrs.

HM-46 SPEAKER-MICROPHONE

Slim dimensions. Equipped with an earphone jack and a transmit indicator.

HM-54 SPEAKER-MICROPHONE

For operation while conveniently hanging the transceiver from your belt, etc.

HM-75A SPEAKER-MICROPHONE

Allows you to remotely select operating channels, etc.

HS-51 HEADSET

For hands-free operation. Includes VOX, PTT and "one-touch" PTT with a time-out timer.

MB-68 BELT CLIP

Allows you to attach the transceiver to your belt. Same as supplied.

LC-145 CARRYING CASE

Helps protect the transceiver from scratches, etc. Usable with any battery pack.

OPC-254L DC POWER CABLE

CP-12L CIGARETTE LIGHTER CABLE WITH NOISE FILTER

Allows you to charge a battery pack connected to the transceiver via a DC power source (12–16 V DC) For charging ONLY—the transceiver cannot be simultaneously operated.

SP-13 EARPHONE

Count on us!

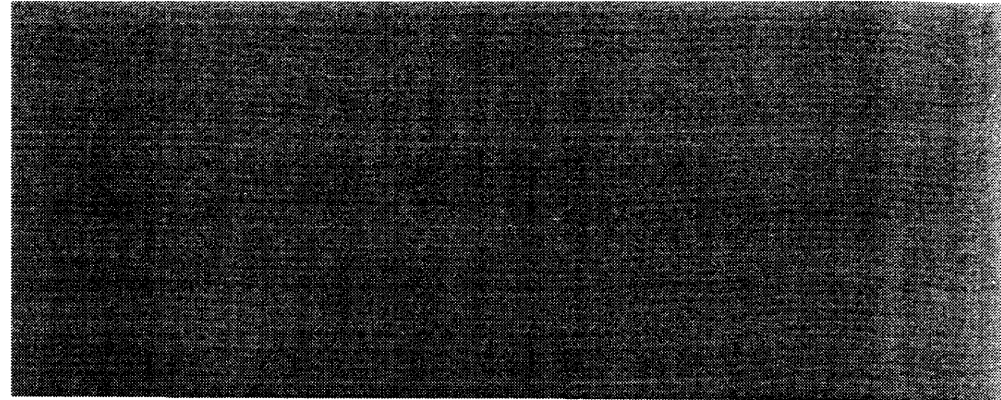

A-5556D-1EU-①
Printed in Japan
© 1998 Icom Inc.

Icom Inc.
6-9-16 Kamihigashi, Hirano-ku, Osaka 547-0002 Japan